

Plunger Pumps

Please read and save these instructions. Read carefully before attempting to assemble, install, operate or maintain the product described. Protect yourself and others by observing all safety information. Failure to comply with instructions could result in personal injury and/or property damage! Retain instructions for future reference.

Description

Plunger Pumps are designed for a wide variety of high pressure washing applications. They are constructed of die-cast bodies and feature a forged brass head. Internal components include special thick solid ceramic plungers for long life and durability. Precision cast cooling fins are anodized for maximum heat dissipation. Oversized tapered roller bearings and the precision supports assure proper shaft alignment and maximum life. Valve cages of special designed Ultra-Form provide positive seating and extended life. One-piece connecting rods are either a special alloy aluminum or bronze oversized for strength and load disbursement. These pumps are designed for gearbox, belt drive, or coupling drive systems, electric motor 182-184 frame driven systems, or gasoline engine driven systems.

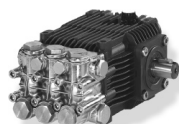

Figure 1 - RKHN



Figure 2 - RK-F17



Figure 3 - RK-F24

RK 1450 rpm N Version

Model	Max GPM	Max PSI
RK11.14N	2.9	2000
RK11.20HN	2.9	2900
RK13.12N	3.43	1740
RK13.20HN	3.43	2900
RK14.16N	3.7	2300
RK15.15N	3.96	2200
RK15.20HN	3.96	2900
RK15.28HN	3.96	4000
RK18.20HN	4.75	2900
RK18.28H	4.75	4000
RK21.20HN	5.55	2900

RKA 1750 rpm N Version

Model	Max GPM	Max PSI
RKA3.5G25N	3.5	2500
RKA3.5G30N	3.5	3000
RKA3.5G40HN	3.5	4000
RKA4G20N	4.0	2000
RKA4G30N	4.0	3000
RKA4G30HN	4.0	3000
RKA4G35N	4.0	3500
RKA4G40HN	4.0	4000
RKA4.5G17N	4.5	1700
RKA4.5G25HN	4.5	2500
RKA4.5G35HN	4.5	3500
RKA5.5G13N	5.5	1300
RKA5.5G20HN	5.5	2000
RKA5.5G30HN	5.5	3000

Model	Max GPM	Max PSI
RKA6.5G20HN	6.6	2000
RKA7G20HN	7.1	2000

RKA 1750 rpm E Version 1-1/8"

Model	Max GPM	Max PSI
RKA3.5G30E-F17	3.5	3000
RKA3.5G30HE-F17	3.5	3000
RKA3.5G40HE-F17	3.5	4000
RKA4G20E-F17	4.0	2000
RKA4G30E-F17	4.0	3000
RKA4G30HE-F17	4.0	3000
RKA5.5G13E-F17	5.5	1300
RKA6.5G20HE-F17	6.6	2000
RKA7G20HE-F17	7.1	2000

RKV 3400 rpm D Version - 1"

Model	Max GPM	Max PSI
RKV3.5G30AD-F24	3.5	3000
RKV3.5G35D-F24	3.5	3500
RKV3.5G40HD-F24	3.5	4000
RKV4037	3.5	3700
RKV4G30AD-F24	4.0	3000
RKV4G32D-F24	4.0	3200
RKV4G35HD-F24	4.0	3500
RKV4G40HD-F24	4.0	4000
RKV4.5G22D-F24	4.5	2200
RKV4.5G40HD-F24	4.5	4000
RKV5G40HD-F24	5.0	4000
RKV5.5G40HD-F24	5.5	4000

RK

N version
Solid shaft pump / \varnothing 24 mm

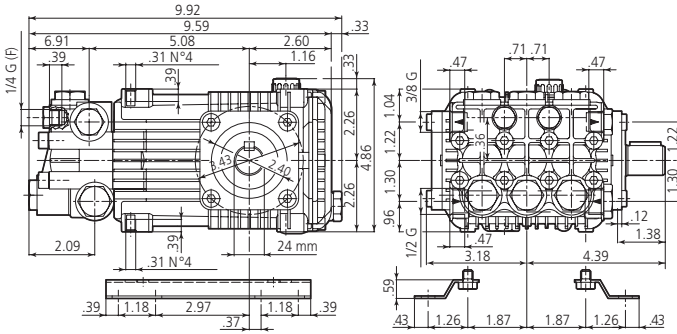

RKA

E version + F17
Hollow shaft pump \varnothing 1" 1/8

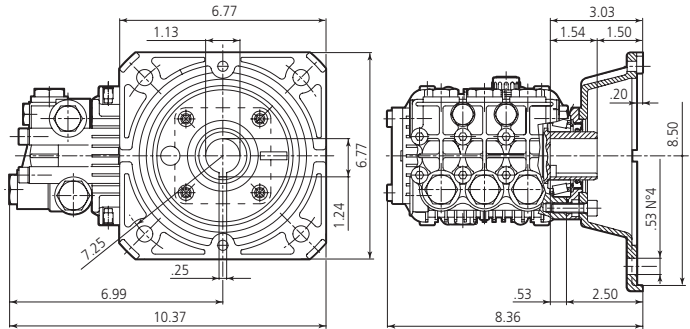

RKV

D version + F24
Hollow shaft pump \varnothing 1"

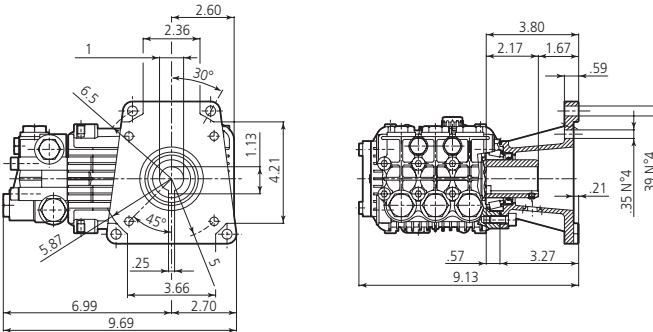

SPRAY NOZZLE CHART

Nozzle #	1000	1200	1400	1600	1800	2000	2200	2400	2600	2800	3000	3200	3400	3600	3700	4000	4200	4400	4600	4800	5000	
	PSI	PSI	PSI	PSI	PSI	PSI	PSI	PSI	PSI	PSI	PSI	PSI	PSI	PSI	PSI	PSI	PSI	PSI	PSI	PSI	PSI	PSI
2.0	1.00	1.10	1.18	1.26	1.34	1.41	1.48	1.55	1.61	1.67	1.73	1.79	1.84	1.90	1.92	2.00	2.05	2.10	2.14	2.19	2.40	
2.25	1.13	1.23	1.33	1.42	1.51	1.59	1.67	1.74	1.81	1.88	1.95	2.01	2.07	2.13	2.16	2.25	2.31	2.36	2.41	2.46	2.52	
2.5	1.25	1.37	1.48	1.58	1.68	1.77	1.85	1.94	2.02	2.09	2.17	2.24	2.30	2.37	2.40	2.50	2.56	2.62	2.68	2.74	2.80	
2.75	1.38	1.51	1.63	1.74	1.84	1.94	2.04	2.13	2.22	2.30	2.38	2.46	2.54	2.61	2.64	2.75	2.82	2.88	2.95	3.01	3.07	
3.0	1.50	1.64	1.77	1.90	2.01	2.12	2.22	2.32	2.42	2.51	2.60	2.68	2.77	2.85	2.89	3.00	3.07	3.15	3.22	3.29	3.35	
3.25	1.63	1.78	1.92	2.06	2.18	2.30	2.41	2.52	2.62	2.72	2.81	2.91	3.00	3.08	3.13	3.25	3.33	3.41	3.49	3.56	3.63	
3.5	1.75	1.92	2.07	2.21	2.35	2.47	2.60	2.71	2.82	2.93	3.03	3.13	3.23	3.32	3.37	3.50	3.59	3.67	3.75	3.83	3.91	
4.0	2.00	2.19	2.37	2.53	2.68	2.83	2.97	3.10	3.22	3.35	3.46	3.58	3.69	3.79	3.85	4.00	4.10	4.20	4.29	4.38	4.47	
4.5	2.25	2.46	2.66	2.85	3.02	3.18	3.34	3.49	3.63	3.76	3.90	4.02	4.15	4.27	4.33	4.50	4.61	4.72	4.83	4.93	5.03	
5.0	2.50	2.74	2.96	3.16	3.35	3.54	3.71	3.87	4.03	4.18	4.33	4.47	4.61	4.74	4.81	5.00	5.12	5.24	5.36	5.48	5.59	
5.5	2.75	3.01	3.25	3.48	3.69	3.89	4.08	4.26	4.43	4.60	4.76	4.92	5.07	5.22	5.29	5.50	5.64	5.77	5.90	6.02	6.15	
6.0	3.00	3.29	3.55	3.79	4.02	4.24	4.45	4.65	4.84	5.02	5.20	5.37	5.53	5.69	5.77	6.00	6.15	6.29	6.43	6.57	6.71	
6.5	3.25	3.56	3.85	4.11	4.36	4.60	4.82	5.03	5.24	5.44	5.63	5.81	5.99	6.17	6.25	6.50	6.66	6.82	6.97	7.12	7.27	
7.0	3.50	3.83	4.14	4.43	4.70	4.95	5.19	5.42	5.64	5.86	6.06	6.26	6.45	6.64	6.73	7.00	7.17	7.34	7.51	7.67	7.83	
7.5	3.75	4.11	4.44	4.74	5.03	5.30	5.56	5.81	6.05	6.27	6.50	6.71	6.91	7.12	7.21	7.50	7.69	7.87	8.04	8.22	8.39	
8.0	4.00	4.38	4.73	5.06	5.37	5.66	5.93	6.20	6.45	6.69	6.93	7.16	7.38	7.59	7.69	8.00	8.20	8.39	8.58	8.76	8.94	
8.5	4.25	4.66	5.03	5.38	5.70	6.01	6.30	6.58	6.85	7.11	7.36	7.60	7.84	8.06	8.18	8.50	8.71	8.91	9.12	9.31	9.50	
9.0	4.50	4.93	5.32	5.69	6.04	6.36	6.67	6.97	7.26	7.53	7.79	8.05	8.30	8.54	8.66	9.00	9.22	9.44	9.65	9.86	10.06	
9.5	4.75	5.20	5.62	6.01	6.37	6.72	7.05	7.36	7.66	7.97	8.23	8.50	8.76	9.01	9.14	9.50	9.73	9.96	10.19	10.41	10.62	
10.0	5.00	5.48	5.92	6.32	6.71	7.07	7.42	7.75	8.06	8.37	8.66	8.94	9.22	9.49	9.62	10.00	10.25	10.49	10.72	10.95	11.18	
11.0	5.50	6.02	6.51	6.96	7.38	7.78	8.16	8.52	8.87	9.20	9.53	9.84	10.14	10.44	10.58	11.00	11.27	11.54	11.80	12.05	12.30	
12.0	6.00	6.57	7.10	7.59	8.05	8.49	8.90	9.30	9.67	10.04	10.39	10.73	11.06	11.38	11.54	12.00	12.30	12.59	12.87	13.15	13.42	
12.5	6.25	6.85	7.40	7.91	8.39	8.84	9.27	9.68	10.08	10.46	10.83	11.18	11.52	11.86	12.02	12.50	12.81	13.11	13.40	13.69	13.98	
13.0	6.50	7.12	7.69	8.22	8.72	9.19	9.64	10.07	10.48	10.88	11.26	11.63	11.99	12.33	12.50	13.00	13.32	13.63	13.94	14.24	14.53	

Gallons Per Minute

Plunger Pumps

<i>Formulas</i>	<i>Conversions</i>
-----------------	--------------------

Nozzles:

Impact Force (lbs.) = .0526 x GPM x √PSI

Nozzle # = GPM x $\frac{4000}{\sqrt{PSI}}$

GPM = Nozzle # x $\frac{PSI}{\sqrt{4000}}$

PSI = (GPM/Nozzle #)² x 4000

Horse Power:

$\frac{GPM \times PSI}{1714}$ = Hydraulic HP

$\frac{GPM \times PSI}{1457}$ = EBHP

$\frac{EBHP \times 1457}{PSI}$ = GPM

$\frac{EBHP \times 1457}{GPM}$ = PSI

HP loss due to altitude = 3% per 1000 FT above sea level

Pump Speed and Flow:

Rated GPM = $\frac{\text{Desired GPM}}{\text{Desired RPM}} \times \text{Rated RPM}$

$\frac{\text{Motor Pulley } \varnothing}{\text{Pump RPM}} = \frac{\text{Pump Pulley } \varnothing}{\text{Motor RPM}}$

Gallons x 3.785412 = Liters

Gallons x 128 = Oz.

PSI x .06896 = Bar

Bar x 14.5038 = PSI

1 inches = 25.4 millimeters

Liters x .2642 = Gallons (US)

Ft. Lbs. x 1.356 = Newton Meters

Inch Lbs. x .11298 = Newton Meters

Newton Meters x .737562 = Ft. Lbs. (force)

Newton Meters x 8.85 = In. Lbs. (force)

Temperature = 1.8(C° + 17.78) = F°, .555(F° - 32) = C°

1 U.S. Gallon of freshwater = 8.33 lbs.

1 PSI = 2.31 feet of water

1 PSI = 2.04 inches of mercury

1 Foot of water = .433 PSI

1 Foot of water = .885 inches of mercury

1 Meter of water = 3.28 feet of water

Kilograms x 2.2 = Lbs.

General Safety Information

⚠ WARNINGS

Gasoline Drive Pumps

 The pump is designed to pump non-flammable or non-explosive fluids.

These pumps are intended to pump clean filtered water only.

 Do not operate in or around an explosive environment.

 Always wear safety glasses or goggles and appropriate clothing.

 Do not alter the pump from the manufacturers design.

 Do not allow children to operate the pump.

 Never point the high-pressure discharge at a person, any part of the body or animals.

Do not operate gasoline engines in a confined area; always have adequate ventilation.

 Do not exceed the pump specifications in speed or pressure.

Plunger Pumps

General Safety Information (continued)

 Maximum water temperature is 140°F.

All positive displacement plunger pumps must have a safety relief valve installed on the discharge side of the pump, this valve could be either an unloader or regulator and must be of adequate flow and pressure for the pump.

Adequate protective guards must cover all moving parts. Perform routine maintenance on the pump and components.

Use only components that are rated for the flow and pressure of the pump, this would include hose, fittings, safety valves, spray guns etc.

Electric Drive Pumps

Your power supply must conform to the system requirements.

 The motor must be grounded. Use GFCI plugs and receivers.

 Do not handle the pump/motor with wet hands.

 Only use power cords that are in good condition.

 Never pull the unit by the power cord.

Never spray or clean the unit with water

Failure to follow these warnings may result in personal injury or damage to property.

Special Features

Wet End

Manifold: Forged Brass: Strength and no porosity – long life. higher hydrostatic pressures – safety, performance.

Inlet and Discharge Ports: Heavy bosses for added strength. **Offset Discharge Ports:** High efficiency, smooth flow. **Bolts:** Eight bolts, 8mm, grade 8.8.

Valves: Valve Caps: Stainless steel on pumps rated at 3200 PSI and higher, better hydrostatic loads. Machined brass on pumps <3200 PSI. **Ultra Form Cages:** Durable, strength, and long life. **Poppets, Seat and Spring:** 303 and 400 series stainless steel.

Packing and Plungers: High Pressure Packing: “V” style (D-1) Buna-N (cotton duct weave base) strong and tightens under load. **Low Pressure Seals:** “U” cup double lip Buna-N for a good positive seat. **Support and Guides:** Machined brass, 1-piece construction to assure proper plunger alignment and to maximize packing and seal life. **Plungers:** Are a special aluminum oxide blend, solid ceramic for long life, strong durability and more resilient.

Drive End

Bearings: Oversized tapered roller bearing for maximum life and load disbursement.

Bearing Support: Precision die-cast and machined to assure concentricity and alignment.

Plunger Pumps

Special Features (continued)

Crankcase: Precision die-cast, large cooling fins and anodized (for maximum heat dissipation).

Rear Cover: Precision die-cast, O-ring sealed and bayonet style sight glass for positive sealing and locking (no threads to loosen).

Plunger Rods: Stainless steel construction for strength (no plating to scrape off), back-up and O-ring plunger sealing system.

Rod Pins: Precision ground and hardened steel, oversized for load disbursement.

Connecting Rods: One-piece special allow aluminum (3XU51, 3XU60 and 3XU68) or bronze (3XU52, 3XU54, 3XU61 and 3XU62) for higher pressure, oversized for maximum strength, load disbursement, and life. Heavy pin area construction, for added load strength.

Crankshaft: Forged, precision ground and hardened for extremely long life and durability.

Oil Seals and O-rings: Triple lip oil seals, long life and much less leak prone. All are constructed of Buna-N rubber. The O-rings have stainless steel garder springs to assure constant tension on the sealing surface.

Oil Drains: Quantity of two (2). One in the rear cover and one in the bottom of the crankcase.

Oil Capacity: 15.5 oz.

Extra Features

Dyno Proven: All pumps are dyno tested to assure the theoretical design meets the actual design.

Valve Design: Each pump series has a valve design that optimizes its highest efficiency.

Installation

Direct Drive Electric and Gasoline Pumps

1. Install the shaft key into the keyway and apply a light coating of anti-seize on the engine shaft.



Figure 4

2. Align the two key ways and push the pump completely onto the engine. (See Figure 4 & 5)

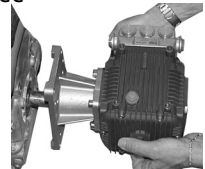

Figure 5

3. Install all four (4) bolts and tighten evenly.

4. Remove the red shipping oil cap and install the black crankcase vent cap. (See Figure 6)

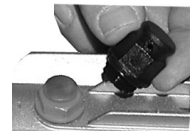

Figure 6

5. Install the appropriate unloader valve and other accessories.
6. Install the appropriate water inlet and discharge fittings.
7. Connect the water supply hose and high-pressure discharge hose/spray gun.
8. Turn on the water supply.

Plunger Pumps

Installation (continued)

9. Open the spray gun to purge the system of any air.
10. Start the engine.
11. Adjust the engine speed and unloader valve.

Belt Drive Systems

1. Mount the pump securely to the base plate. (See Figure 7) For new installation a mounting rail kit is required, refer to parts breakdown.

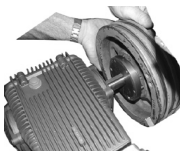

Figure 7

2. Install the pump pulley on the crankshaft. It should be as far onto the shaft as possible.



Figure 8

3. Align the pulleys so they are in line. (See Figure 8)

4. Use a belt tension gauge to assure proper tension (too much tension can cause bearing failure or damage the belts as well as cause other problems). (See Figure 9)

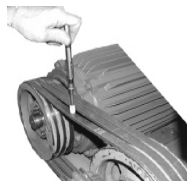

Figure 9

5. Installation complete.

Winter or Long Time Storage

1. Drain all of the water out of the pump.
2. Run a 50% solution of a RV or non-toxic/biodegradable antifreeze through the pump.

3. Flush the pump with fresh water before the next use.
4. In freezing conditions failure to do this may cause internal pump damage.
5. For long periods of storage in non-freezing areas the solution will keep the seals and O-rings lubricated.

Service Pumps

Servicing the Valves

The inlet and discharge valves in this series pumps are all the same. The valves are located under the six 24mm hex plugs. The inlet valves are located on the lower row and the discharge valves are located on the top row of the pump head.

Tools required: 24mm socket, ratchet, needle nose pliers, mechanics pick and torque wrench.

Valve Removal:

1. Remove the valve cap.
2. Inspect the valve cap O-ring for any damage, replace if necessary. (See Figure 10)
3. Use the needle nose pliers to remove the valve. (See Figure 11)



Figure 10



Figure 11

Plunger Pumps

Service Pumps (continued)

4. Use a small probe to move the poppet up and down to assure that the valve is functioning properly and that no debris is stuck in the valve. (See Figure 12)



Figure 12

5. Using the mechanics pick remove the valve seat O-ring and inspect for any damage, replace if necessary. (See Figure 13)

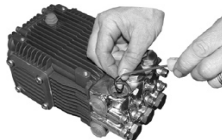

Figure 13

Valve Assembly:

1. Install the valve seat O-ring squarely into the bottom of the manifold. (See Figure 14)
2. Insert the valve assembly squarely into the port pushing it into the O-ring. (See Figure 15)
3. Install the valve cap and torque to the proper specification. (See Figure 16) (See parts breakdown)



Figure 14



Figure 15



Figure 16

Servicing the Packings/Seals

To access the water seals for inspection or replacement, you will first need to remove the head of the pump.

Tools required: 6mm hex socket, ratchet, (2) long screwdrivers, reversible pliers, mechanics pick and torque wrench.

Disassembly:

1. First remove the eight 6mm head bolts. (See Figure 17)
2. Place the screwdrivers as shown between the head and crankcase of the pump, lifting one up and the other down. The head should start to lift off of the plungers. (See Figure 18)



Figure 17

3. When you remove the head you may notice that some of the water seals have stayed on the plungers and some in the head. (See Figure 19) To remove the seals from the plungers simply turn the assemblies and pull off.



Figure 18



Figure 19

4. If the seal assemblies are in the head use the reversible pliers to grab the seal retainer on the inside bore
(NOTE: Use a rag so you do not mar the piston guide area), twist the retainer in either direction



Figure 20

Plunger Pumps

Service Pumps (continued)

(NOTE: This is done to free the retainer O-ring which is stuck to the manifold) and lift out. (See Figure 20 & 21)



Figure 21

5. With your fingers pull the high pressure seal and head ring out of the head. (See Figure 22)



Figure 22

6. The low-pressure seal is located in the brass seal retainer. Using the mechanics pick go in between the seal and retainer, twist and pull, the seal will come out of the gland. (See Figure 23 & 24)

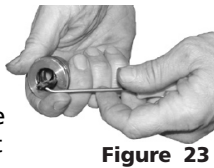

Figure 23

7. Remove the seal retainer O-ring with the mechanics pick. (See Figure 25)



Figure 24

Assembly:

1. Install the plastic head ring into the head (the flat side is on the bottom). (See Figure 26)



Figure 25

2. Install the high-pressure seal. Place the seal so the open "V" portion is toward the head ring. You need to place the

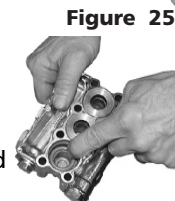

Figure 26

seal at an angle and pull and push to work the seal into position with your fingers (do not use and tools you may damage the seal). Make sure the seal is totally seated against the head ring. (See Figure 27 & 28)



Figure 27

3. Installing the low-pressure seal. You want the open side of the seal to be pointed toward the water side of the head (toward the high-pressure seal) and the flat side toward the drive end of the pump.



Figure 28

Place the seal into the gland at an angle, with your finger push the exposed side of the seal towards the center and work the seal (See Figure 29, 30 & 31) into position. After the seal is in the gland you can work it into its proper position.



Figure 29

4. Install the retainer O-ring. (See Figure 32)



Figure 30



Figure 31



Figure 32

Plunger Pumps

Service Pumps (continued)

- Squarely seat the retainer into the head and push with even pressure until it snaps into position. (See Figure 33)



Servicing the Plungers

If the plungers are not damaged they do not need any servicing.

Tools required: 16mm socket, ratchet, mechanics pick, taper blade gasket scraper, thread sealant and torque wrench.

NOTE: Be very careful when working with the plungers, they are made from ceramic which is brittle and can be damaged.

Any time you remove a plunger it is recommended you replace the slinger washer, O-ring and top plunger washer. The washers are a cushion for the ceramic plunger and compress when first used and the O-ring will take a set to create a seal and usually will not spring back to its original shape. By not replacing these parts you run the risk of breaking a plunger or having a water leak.

Disassembly:

- Remove the plunger retainer nut. (See Figure 34)
- Insert the gasket scraper between the copper washer and plunger to remove the washer. (See Figure 35)



Figure 34



Figure 35

- Twist and pull the plunger off the plunger rod.
- Remove the plunger rod O-ring seal and split back-up ring with the mechanics pick. (See Figure 36 & 37)
- Remove brass slinger. At this point clean any thread locker that is left on the plunger rod and retaining nut threads. (See Figure 38)



Figure 36



Figure 37



Figure 38

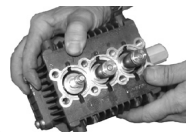

Figure 39

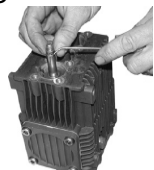

Figure 40



Figure 41

Assembly:

- Install the slinger washer. (See Figure 39)
- Install the plunger rod O-ring and split back-up ring. Place a light film of oil on the O-ring and back-up ring. (See Figure 40)
- Install the plunger by pushing straight down and twisting slightly in either direction (See Figure 41)

NOTE: The O-ring is closest to the threaded end of the rod.

(NOTE: Be sure that the back-up ring is fully seated). Make sure you fully seat the plunger.

Plunger Pumps

Service Pumps (continued)

4. Install the small copper washer on top of the plunger and place a small quantity of thread sealant in the thread. Install the plunger nut and tighten to the required torque. (See Figure 42 & 43) (See parts breakdown)



Figure 42



Figure 43

Oil Change

Change oil after first 50 hours of use. Then every 500 hours. Refer to parts breakdown for oil type.

Pump head to drive end Installation

1. Turn the crankshaft to align the plungers as shown. (See Figure 44)
2. Place the head evenly onto the plungers and push it until it makes contact with the drive end of the pump. (See Figure 45)
3. Torque the head bolt as shown in the tightening sequence diagram. (See Figure 46 & 47) (See parts breakdown).



Figure 44



Figure 45



Figure 46



Figure 47

Troubleshooting

Symptom	Possible Cause(s)	Corrective Action
Oil leak between crankcase and pumping section	Worn rod oil seals	Replace crankcase piston rod seals
Frequent or premature failure of the packing	1 Cracked, damaged or worn plunger	1 Replace plungers
	2 Overpressure to inlet manifold	2 Reduce inlet pressure
	3 Material in the fluid being pumped	3 Install proper filtration on pump inlet plumbing
	4 Excessive pressure and/or temperature of fluid being pumped	4 Check pressures and fluid inlet temperature; be sure they are within specified range
	5 Running pump dry	5 Do not run pump without water
Pump runs but produces no flow	Pump is not primed	Flood suction then restart pump
Pump fails to prime	Air is trapped inside pump	Disconnect discharge hose from pump. Flood suction hose, restart pump and run pump until all air has been evacuated
Pump loses prime, chattering noise, pressure fluctuates	1 Air leak in suction hose or inlet	1 Remove suction line and inspect it for a loose liner or debris lodged in hose. Avoid all unnecessary bends. Do not kink hose
	2 Clogged suction strainer	2 Clean strainer
Low pressure at nozzle	1 Unloader valve is by-passing	1 Make sure unloader is adjusted properly and by-pass seat is not leaking
	2 Incorrect or worn nozzle	2 Make sure nozzle is matched to the flow and pressure of the pump. If the nozzle is worn, replace
	3 Worn packing or valves	3 Replace packing or valves
Pressure gauge fluctuates	1 Valves worn or blocked by foreign bodies	1 Clean or replace valves
	2 Packing worn	2 Replace packing
Low pressure	1 Worn nozzle	1 Replace with nozzle of proper size
	2 Belt slippage	2 Tighten or replace with correct belt

Troubleshooting (cont.)

Symptom	Possible Cause(s)	Corrective Action
Low pressure (cont.)	3 Air leak in inlet plumbing	3 Disassemble, reseal and reassemble
	4 Relief valve stuck, partially plugged or improperly adjusted valve seat worn	4 Clean and adjust relief valve; check for worn or dirty valve seats
	5 Worn packing. Abrasive in pumped in cavitation. Inadequate water	5 Install proper filter suction at inlet manifold must be limited to lifting less than 20 feet of water or 8.5 psi vacuum
	6 Worn inlet, discharge valve blocked or dirty	6 Replace inlet and discharge valve
Pump runs extremely rough, pressure very low	1 Inlet restrictions and/or air leaks.	1 Clean out foreign material
	2 Stuck inlet or discharge valve	2 Replace worn valves
Water leakage from under manifold	Worn packing or cracked plunger	Install new packing or plunger
Slight leak, oil leaking in the area of crankshaft	1 Worn crankshaft seal or improperly installed oil seal o-ring	1 Remove oil seal retainer and replace damaged O-ring and/or seals
	2 Bad bearing	2 Replace bearing
Excessive play in the end of the crankshaft pulley	Worn main bearing from excessive tension on drive belt	Replace crankcase bearing and/or tension drive belt
Water in crankcase	1 Humid air condensing into water inside the crankcase	1 Change oil intervals
	2 Worn packing and/or cracked plunger	2 Replace packing. Replace plunger
Loud knocking noise in pump	1 Cavitation or sucking air	1 Check water supply is turned on
	2 Pulley loose on crankshaft	2 Check key and tighten set screw
	3 Broken or worn bearing	3 Replace bearing

RK 1450 RPM

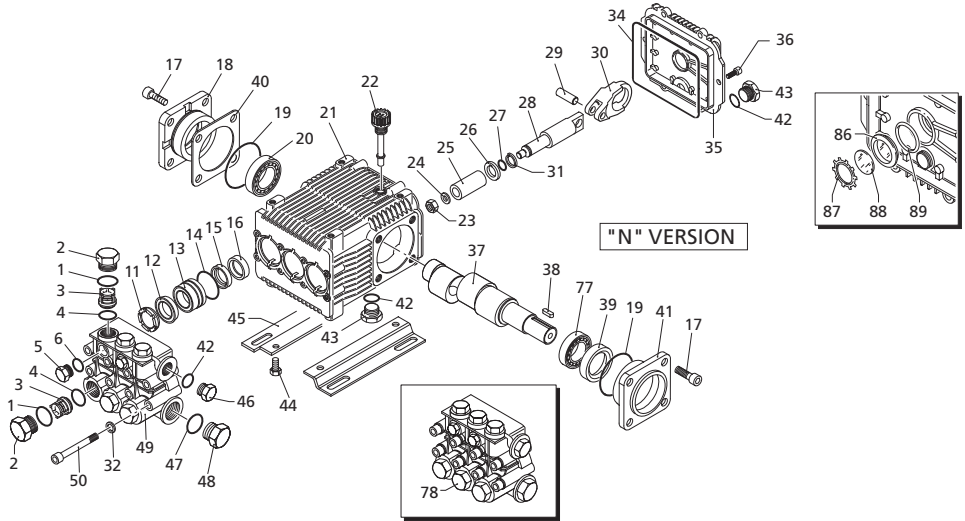

Repair Kits

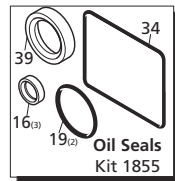
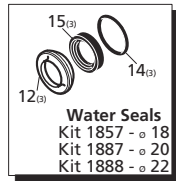
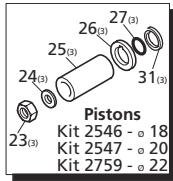
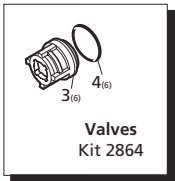

Special Parts / Kits

Code	Description	Qty.
2809	Viton water seals ø18	1
2810	Viton water seals ø20	1
2811	Viton water seals ø22	1
2820	Kit for up to 180° F ø20 High Temp	1
1837	Rail Kit 5/8" - 2 Rails & 4 Bolts	1
2633	Rail Kit 1-3/4" - 2 Rails & 4 Bolts	1
2633H	Rail Kit 2-5/8" - 2 Rails & 4 Bolts	1



Pos.	Code	Description	Qty.	Pos.	Code	Description	Qty.
1	960160	O-Ring $\phi 17.86 \times 2.62$	6	40	1380120	Shim 0.10 mm	1-3
2	960090	Valve cap - Brass	(478 in/lbs) 6		1380130	Shim 0.20 mm	1-3
	960850	Valve cap - SS	(478 in/lbs) \varnothing 6		1380530	Shim 0.25 mm	1-3
	1380740	Valve cap - NP	(478 in/lbs) 6		1382810	Shim 0.05 mm	1-3
	960090T	Valve cap - 1/4" threaded - Brass	(478 in/lbs) 1	41	1380040	Open bearing support	(217 in/lbs) 1
	960850T	Valve cap - 1/4" threaded - SS	(478 in/lbs) 1	42	740290	O-Ring $\phi 14 \times 1.78$	3
3	1389051	Complete valve	6	43	1980740	Plug 3/8" G	2
4	880830	O-Ring $\phi 15.54 \times 2.62$	6	44	1260470	Bolt M8x10	4
5	880581	Plug 1/4" G - Brass	2	45	1380141	Rail 5/8"	2
	1380690	Plug 1/4" G NP	\varnothing 2		Z-Bracket 1-3/4"	Rail 1-3/4"	2
6	820510	O-Ring $\phi 10.82 \times 1.78$	2		Z-Bracket	Rail 2-5/8"	2
11	960110	Support ring	$\phi 18 \blacksquare$ 3	46	1980740	Plug 3/8" G	1
	840300	Support ring	$\phi 20 \blacksquare$ 3	47	1981180	Plug 3/8" G NP	\varnothing 1
	840320	Support ring	$\phi 22 \star$ 3	48	180101	O-Ring $\phi 17.5 \times 2$	1
12	880320	High pressure packing	$\phi 18 \blacksquare$ 3		820361	Plug 1/2" G	1
	840290	High pressure packing	$\phi 20 \blacksquare$ 3	48	960870	Plug 1/2" G NP	\varnothing 1
	840330	High pressure packing	$\phi 22 \star$ 3	49	1381070	Pump head - NP	$\phi 18 \varnothing$ 1
13	1380090	Piston guide	$\phi 18 \blacksquare$ 3		1381071	Pump head - Brass	$\phi 18 \blacksquare$ 1
	1380150	Piston guide	$\phi 20$ 3		1380020	Pump head - Brass	$\phi 20-22$ 1
	1380160	Piston guide	$\phi 22 \star$ 3		1380680	Pump head - NP	$\phi 20-22$ 1
14	961240	O-Ring $\phi 31.47 \times 1.78$	3	50	820150	Head bolt M8x70	(217 in/lbs) 8
15	880330	Low pressure seal	$\phi 18 \blacksquare$ 3	77	840370	Bearing	1
	840280	Low pressure seal	$\phi 20 \blacksquare$ 3	78	1389270	Complete pump head	$\phi 18 \blacksquare$ 1
840340	Low pressure seal	$\phi 22 \star$ 3			1389272	Complete pump head	$\phi 18 \blacksquare$ 1
16	1383130	Oil seal	3		1389271	Complete pump head	$\phi 18 \varnothing$ 1
17	850370	Bolt M8x16	(217 in/lbs) 8		1389212	Complete pump head	$\phi 20 \blacksquare$ 1
18	1380050	Closed bearing support	1		1389220	Complete pump head	$\phi 22 \blacksquare$ 1
19	640030	O-Ring $\phi 59.99 \times 2.62$	2	86	1260250	Oil sight glass	1
20	2280240	Bearing	1	87	1260430	Snap ring	1
21	1382770	Pump housing	1	88	1780690	Contrast disc	1
22	880130	Vented oil cap	1	89	1140450	O-Ring $\phi 20.24 \times 2.62$	1
23	962010	Nut M8	(106 in/lbs) 3		AR64516	Oil	1
24	962000	Washer $\phi 8.1$	3		<i>OIL CAPACITY - 15 oz</i>		
25	1380940	Ceramic piston	$\phi 18 \blacksquare$ 3	Legend			
	1380930	Ceramic piston	$\phi 20 \blacksquare$ 3	$\phi 18$	$\phi 20$	$\phi 22$	
	1382360	Ceramic piston	$\phi 22 \star$ 3	For \blacksquare	For \blacksquare	For \star	
26	1380950	Spacer	3	RK15.15	RK18.20H	RK21.20H	
27	600180	O-Ring $\phi 7.66 \times 1.78$	3	RK15.20H	RK18.28H \varnothing		
28	1380920	Guiding piston	3	RK15.28H \varnothing		\varnothing Over 3600psi	
29	1380060	Piston pin	3				
30	1383020	Con rod - Bronze > 3000 PSI	3				
	1383050	Con rod - Aluminum < 3000 PSI	3				
31	1080401	Back-up ring	3				
32	1381850	Washer	8				
34	1780510	O-Ring	1				
35	1789010	Complete cover	1				
36	1343510	Bolt M6x14	(89 in/lbs) 6				
37	2280070	Crankshaft 24mm	\star 1				
	2280060	Crankshaft 24mm	\blacksquare 1				
38	1380520	Key	1				
39	180340	Oil seal	1				

RKA 1750 RPM

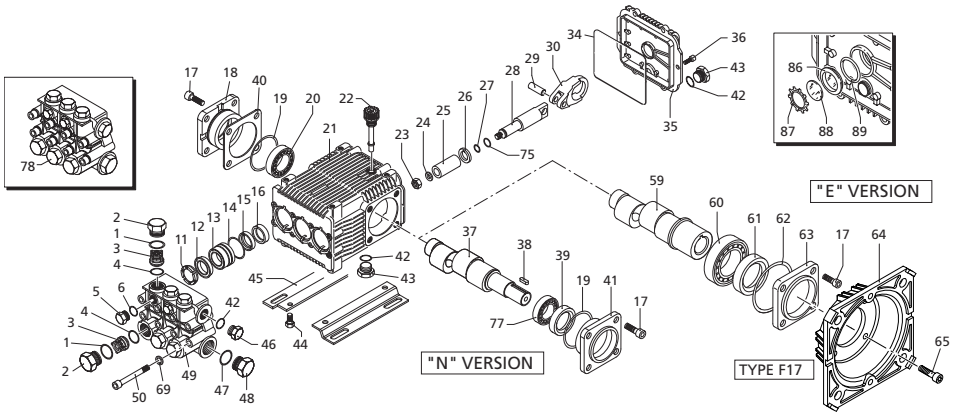

Repair Kits

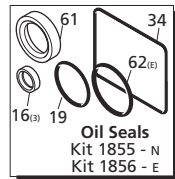
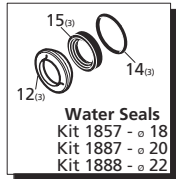
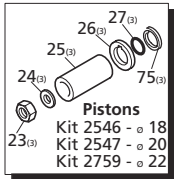
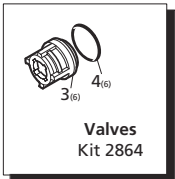

Special Parts / Kits		
Code	Description	Qty.
2809	Viton water seals ø18	1
2810	Viton water seals ø20	1
2811	Viton water seals ø22	1
2820	Kit for up to 180° F ø18 High Temp	1
1837	Rail Kit 5/8" - 2 Rails & 4 Bolts (N only)	1
2633	Rail Kit 1-3/4" - 2 Rails & 4 Bolts (N only)	1
2633H	Rail Kit 2-5/8" - 2 Rails & 4 Bolts (N only)	1

Legend			
ø 18	ø 18	ø 20	ø 22
For ○	For ●	For ■	For ▣
RKA3.5G22	RKA4G20	RKA5.5G13	RKA6.5G13
RKA3.5G25	RKA4G30A	RKA5.5G20H	RKA6.5G20H
RKA3.5G30H	RKA4G30	RKA5.5G26H	
RKA3.5G40H	RKA4G30H	RKA5.5G30H	
	RKA4G35H		
	RKA4G40H		
	For □		
	RKA4.5G17		
	RKA4.5G25H	For ◆	
	RKA4.5G30H	RKA4G35N	
	RKA4.5G35H		
	RKA4.5G40H		
	Over 3600psi		
		For ★	
		RKA7G13	
		RKA7G20H	

Pos.	Code	Description	Qty.	Pos.	Code	Description	Qty.	
1	960160	O-Ring $\phi 17.86 \times 2.62$	6	41	1380040	Open bearing support (217 in/lbs)	1	
2	960090	Valve cap - Brass (478 in/lbs)	6	42	740290	O-Ring $\phi 14 \times 1.78$	3	
	960850	Valve cap - SS (478 in/lbs)	6	43	1980740	Plug 3/8" G	2	
	1380740	Valve cap - NP (478 in/lbs)	6	44	1260470	Bolt M8x10	4	
	960090T	Valve cap - 1/4" threaded - Brass (478 in/lbs)	1		1380141	Rail 5/8" (N Version only)	2	
	960850T	Valve cap - 1/4" threaded - SS (478 in/lbs)	1	45	Z-Bracket 1-3/4	Rail 1-3/4" (N Version only)	2	
3	1389051	Complete valve	6		Z-Bracket	Rail 2-5/8" (N Version only)	2	
4	880830	O-Ring $\phi 15.54 \times 2.62$	6	46	1980740	Plug 3/8" G	1	
5	880581	Plug 1/4" G - Brass	2	47	1981180	Plug 3/8" G NP	1	
	1380690	Plug 1/4" G NP	2	48	180101	O-Ring $\phi 17.5 \times 2$	1	
6	820510	O-Ring $\phi 10.82 \times 1.78$	2		820361	Plug 1/2" G	1	
11	960110	Support ring $\phi 18 \square \blacklozenge$	3		960870	Plug 1/2" G NP	1	
12	840300	Support ring $\phi 20 \blacksquare$	3	50	1381071	Pump head - Brass $\phi 18$	1	
	840320	Support ring $\phi 22 \blacktriangleright$	3		1381070	Pump head - NP $\phi 18$	1	
	880320	High pressure packing $\phi 18 \square \blacklozenge$	3		1380020	Pump head - Brass $\phi 20$	1	
	840290	High pressure packing $\phi 20 \blacksquare$	3		1380680	Pump head - NP $\phi 20$	1	
	840330	High pressure packing $\phi 22 \blacktriangleright$	3		1383010	Pump head - Brass $\phi 22$	1	
	1380090	Piston guide $\phi 18 \square \blacklozenge$	3		1383310	Pump head - NP $\phi 22$	1	
	1380150	Piston guide $\phi 20 \blacksquare$	3		820150	Head bolt M8x70 (217 in/lbs)	8	
	1380160	Piston guide $\phi 22 \blacktriangleright$	3		2280260	Hollow shaft $\phi 1-1/8"$	1	
14	961240	O-Ring $\phi 31.47 \times 1.78$	3		2280200	Hollow shaft $\phi 1-1/8"$	1	
	880330	Low pressure seal $\phi 18 \square \blacklozenge$	3		2280270	Hollow shaft $\phi 1-1/8"$	1	
	840280	Low pressure seal $\phi 20 \blacksquare$	3		2280280	Hollow shaft $\phi 1-1/8"$	1	
	840340	Low pressure seal $\phi 22 \blacktriangleright$	3	59	60	1380320	Bearing	1
16	1383130	Oil seal	3		61	621170	Oil seal	1
17	850370	Bolt M8x16 (217 in/lbs)	8		62	1380220	O-Ring $\phi 72.75 \times 1.78$	1
18	1380050	Closed bearing support	1		63	1380210	Compete cover	1
19	640030	O-Ring $\phi 59.99 \times 2.62$	2		64	1591	Electric Flange F17	1
20	2280240	Bearing	1		65	620610	Bolt	4
21	1382770	Pump housing	1		69	1381850	Washer	8
22	880130	Vented oil cap	1		1389270	Complete pump head - Brass $\phi 18$	1	
23	962010	Nut M8 (106 in/lbs)	3		1389272	Complete pump head - NP $\phi 18$	1	
24	962000	Washer $\phi 8.1$	3		1389271	Complete pump head - NP $\phi 18$	1	
25	1380940	Ceramic piston $\phi 18 \square \blacklozenge$	3		1389208	Complete pump head - Brass $\phi 20$	1	
	1380930	Ceramic piston $\phi 20 \blacksquare$	3		1389212	Complete pump head - NP $\phi 20$	1	
	1382360	Ceramic piston $\phi 22 \blacktriangleright$	3		1389268	Complete pump head - Brass $\phi 22$	1	
26	1380950	Slinger	3		1389269	Complete pump head - NP $\phi 22$	1	
27	600180	O-Ring $\phi 7.66 \times 1.78$	3		75	1080401	Back-up ring	3
28	1380920	Guiding piston	3		77	840370	Bearing	1
29	1380060	Piston pin	3		86	1260250	Oil sight glass	1
30	1383020	Con rod - Bronze > 3000 PSI	3		87	1260430	Snap ring	1
	1383050	Con rod - Aluminum < 3000 PSI	3		88	1780690	Contrast disc	1
34	1780510	O-Ring	1		89	1140450	O-Ring $\phi 20.24 \times 2.62$	1
35	1789010	Complete cover	1			AR64516	Oil	1
36	1343510	Bolt M6x14 (89 in/lbs)	6				OIL CAPACITY - 15 OZ	
	2280100	Crankshaft 24mm \circ	1					
	2280090	Crankshaft 24mm \bullet	1					
	2280070	Crankshaft 24mm $\square \blacksquare$	1					
	2280060	Crankshaft 24mm \star	1					
	2280110	Crankshaft 24mm - NL \blacklozenge	1					
38	1380520	Key	1					
39	180340	Oil seal	1					
	1380120	Shim 0.10 mm	1-3					
	1380130	Shim 0.20 mm	1-3					
	1380530	Shim 0.25 mm	1-3					
40	1382810	Shim 0.05 mm	1-3					

RKV 3400 RPM

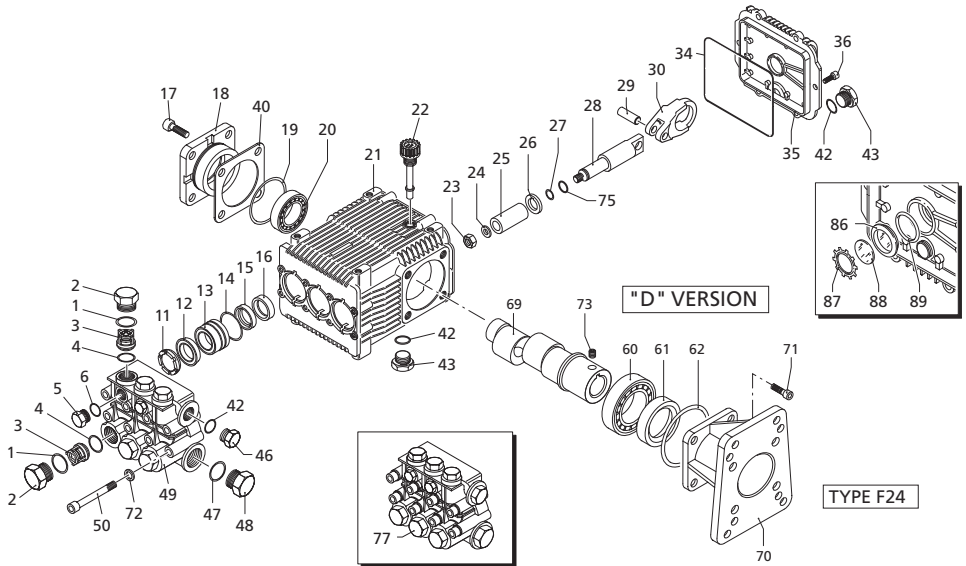

Repair Kits

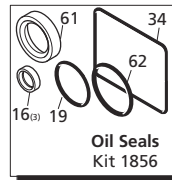
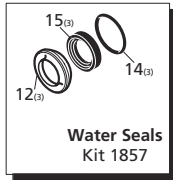
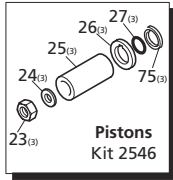
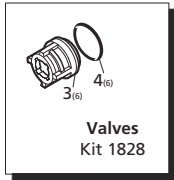

Special Parts / Kits

Code	Description	Qty.
2809	Viton water seals $\varnothing 18$	1

Pos.	Code	Description	Qty.
1	960160	O-Ring ϕ 17.86x2.62	6
2	960090	Valve cap - Brass (478 in/lbs) \circ ●	6
3	960850	Valve cap - SS (478 in/lbs) \square ■◆ \square	6
4	960090T	Valve cap - 1/4" threaded - Brass (478 in/lbs)	1
5	960850T	Valve cap - 1/4" threaded - SS (478 in/lbs)	1
6	889052	Complete valve	6
7	880830	O-Ring ϕ 15.54x2.62	6
8	880581	Plug 1/4" G - Brass \circ ●■	2
9	1380690	Plug 1/4" G - NP \square ★◆ \square	2
10	820510	O-Ring ϕ 10.82x1.78	2
11	960110	Support ring	3
12	880320	High pressure packing	3
13	1380090	Piston guide	3
14	961240	O-Ring ϕ 31.47x1.78	3
15	880330	Gasket	3
16	1383130	Oil seal	3
17	850370	Bolt M8x16 (217in/lbs)	8
18	1380050	Closed bearing support	1
19	640030	O-Ring ϕ 59.99x2.62	2
20	2280240	Bearing	1
21	1382770	Pump housing	1
22	880130	Vented oil cap	1
23	962010	Nut M8 (106 in/lbs)	3
24	962000	Washer ϕ 8.1	3
25	1380940	Ceramic piston	3
26	1380950	Slinger	3
27	600180	O-Ring ϕ 7.66x1.78	3
28	1380920	Guiding piston	3
29	1380060	Piston pin	3
30	1383020	Con rod - Bronze	3
31	1383050	Con rod - Aluminum	3
32	1780510	O-Ring	1
33	1789010	Complete cover	1
34	1343510	Bolt M6x14 (89 in/lbs)	6
35	1380120	Shim 0.10 mm	1-3
36	1380130	Shim 0.20 mm	1-3
37	1380530	Shim 0.25 mm	1-3
38	1382810	Shim 0.05 mm	1-3
39	740290	O-Ring ϕ 14x1.78	3
40	1980740	Plug 3/8" G - Brass	2
41	1980740	Plug 3/8" G - Brass \circ ●■	1
42	1981180	Plug 3/8" G - NP \square ★◆ \square	1
43	180101	O-Ring ϕ 17.5x2	1
44	820361	Plug 1/2" G - Brass \circ ●■	1
45	960870	Plug 1/2" G - NP \square ★◆ \square	1
46	1381071	Pump head - Brass \circ ●■	1
47	1381070	Pump head - NP \square ★◆ \square	1
48	820150	Head bolt M8x70 (217 in/lbs)	8
49	1380320	Bearing	1
50	621170	Oil seal	1
51	1380220	O-Ring ϕ 72.75x1.78	1

Pos.	Code	Description	Qty.
52	2280140	Hollow shaft ϕ 1 \circ ■	1
53	2280130	Hollow shaft ϕ 1 \bullet ■★	1
54	2280590	Hollow shaft ϕ 1 \diamond	1
55	2280600	Hollow shaft ϕ 1 \square	1
56	70 1597	Gas engine flange F24	1
57	72 1381850	Washer	8
58	73 820440	Set screw M6x6	1
59	75 1080401	Back-up ring	3
60	77 2289208	Complete pump head \circ ●	1
61	2289209	Complete pump head ■	1
62	2289221	Complete pump head \square ★◆ \square	1
63	86 1260250	Oil sight glass	1
64	87 1260430	Snap ring	1
65	88 1780690	Contrast disc	1
66	89 1140450	O-Ring ϕ 20.24x2.62	1
67	AR64516	Oil	1

OIL CAPACITY - 15 OZ

Legend			
ϕ 18	ϕ 18	ϕ 18	ϕ 18
For \circ	For \bullet	For \diamond	For \square
RKV3.5G25	RKV4G30A	RKA4.5G32	RKV5.5G40H
RKV3.5G30	RKV4G30	RKV4.5G40H	
	RKV4G36		
	RKV4G37		
For ■	For \square	For ★	
RKV4G32	RKV3.5G35H	RKV4G35H	
	RKV3.5G40H	RKV4G40H	

Plunger Pumps

Instructions for Adjusting Gymatic Unloader Valves

Please follow these easy steps to adjust the pressure:

- Step 1: Remove black cap (pos. #1) from knob.
- Step 2: Loosen bolt (pos. #2) with 6mm hex wrench.
- Step 3: Loosen nut (pos. #3) to top of (pos. #2) bolt.
- Step 4: Turn the black knob (pos. #4) clockwise until it stops.
- Step 5: Start machine hold trigger on open position and turn (pos. #2) bolt until no further increase of pressure is noticed, continue to hold trigger open and turn counterclockwise until a slight drop in pressure is felt.
- Step 6: Spin (pos. #3) nut down. While holder (pos. #2) bolt in place with hex wrench, use special tool (AR1560590) Or extended 13mm socket wrench to hand tighten (pos. #3) nut against (pos. #4) black knob.

Step 7: Replace (pos. #1) black cap.

NOTE: Now pressure can be decreased by turning black knob (pos. #4) counterclockwise, but the pressure cannot be increased to a rating higher than what max is set at by technician.

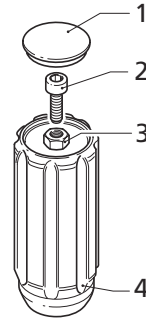

Mounting Bolt Torque Specifications	
Inlet	354 in/lbs 30 ft/lbs
Discharge	221 in/lbs 19 ft/lbs



AR1560590
Nut holder for adjusting Gymatic Unloader

Plunger Pumps

Torque Specifications in/lbs:(ft/lbs)

	Oil Capacity	Manifold (Head)	Piston Nut	Rear Cover	Side Cover	Valve Cap	Connecting Rods
RK	15	217/(18)	106/(8.8)	89/(7.5)	217/(18)	478/(40)	N/A

LIMITED WARRANTY

Annovi Reverberi (A.R.) Cam Shaft Plunger Pumps are warranted for a period of five years and Axial Radial Pumps are warranted for a period of one year to the original purchaser. Electric Pressure Washers are warranted for a period of one year to the original purchaser. This is from the date shipped from factory or U.S. Warehouse. **AR**, **ArrowLine** and **GF** accessories are warranted for a period of 90 days.

Warranty covers manufacturing defects or workmanship; that may develop under normal use and service in a manner up to the directions and usage recommended by the manufacturer.

Warranty does not apply to misuse or when pump or accessory is altered or used in excess of recommended speeds, pressures, temperatures or handling fluids not suitable for pump or accessory material construction. Warranty does not apply to normal wear (*such as but not limited to: seals/packings, valves, plungers and sealing o-rings*), freight damage, freezing damage or damage caused by parts or accessories not supplied by AR North America, Inc.

Liability of manufacturer for warranty is limited to repair or replacement of parts only at the option of the manufacturer when such products are found to be of original defect or workmanship at the time it was shipped from factory. This warranty is in lieu of all other warranties, expressed or implied, including any warranty of merchantability and of any and all other obligations or liabilities on the part of the manufacturers or equipment.

WARRANTY RETURNS

Items returned for warranty consideration must have a **Returned Merchandise Authorization (RMA)** number. All unauthorized returns will be refused and shipped back to sender. Please fax requests to: 763-398-2009 or e-mail to shop@arnorthamerica.com.